

Spill Containment Tray (30 l)

Technical Data



| | Colour options | H x W x D (mm) | Platform (mm) | Weight (kg) | Capacity (l) | Max. load (kg) |
|--------------|----------------|-----------------|----------------|-------------|--------------|----------------|
| ST1-30-XX-BK | ● ● ● | 155 x 805 x 405 | 25 x 795 x 395 | 4.5 | 30 | 50 |
| ST1-30-B-BK | ● | | - | 3 | 39 | - |

XX = Colour options: BK: ● YE: ● GR: ●

Spill Containment Tray (30 I)

Technical Data

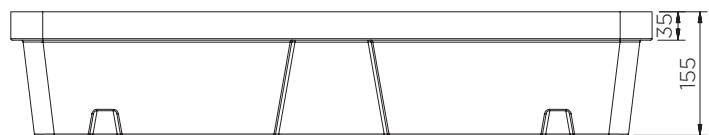
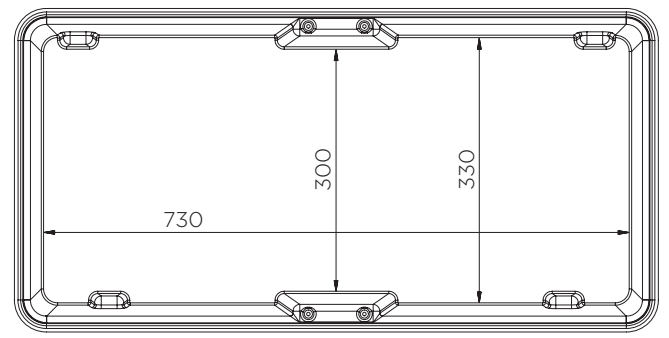
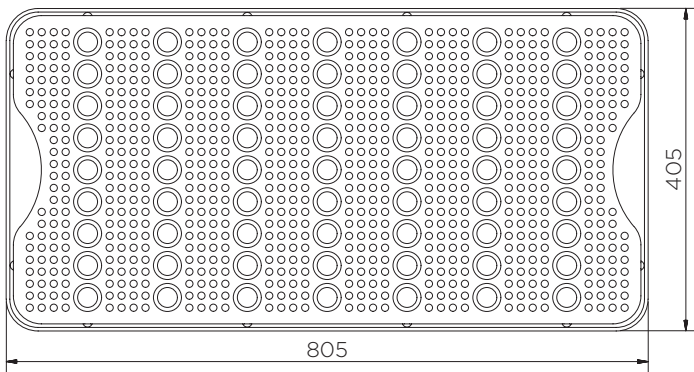
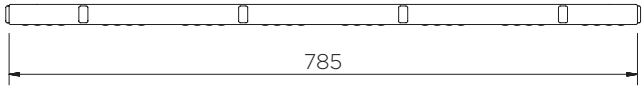
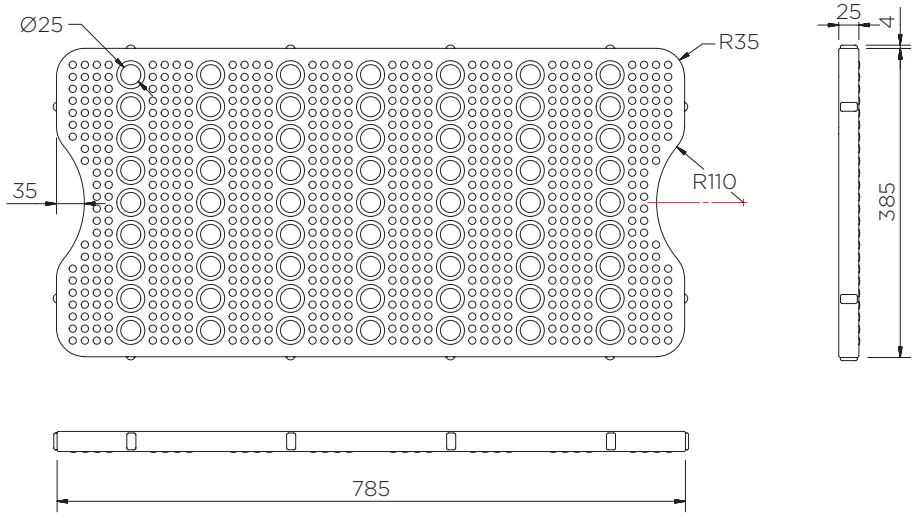

Spill Containment Tray (30 I)

Technical Data

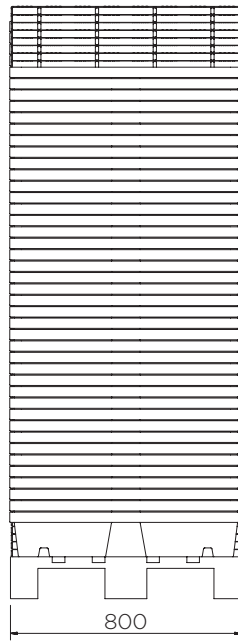
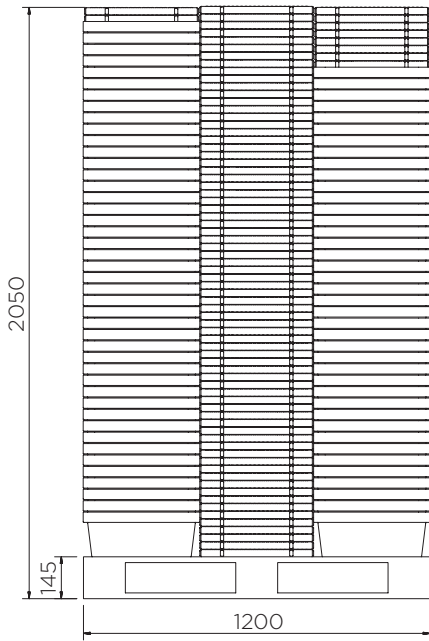

ST1-30-XX-BK

| | |
|-------------------------|------|
| Pieces per pallet | 84 |
| 20' container | 924 |
| 40' high cube container | 2100 |
| 13.6 m trailer | 2772 |

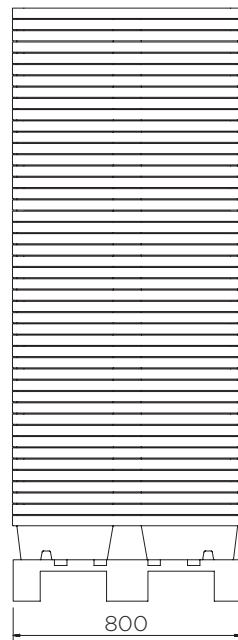
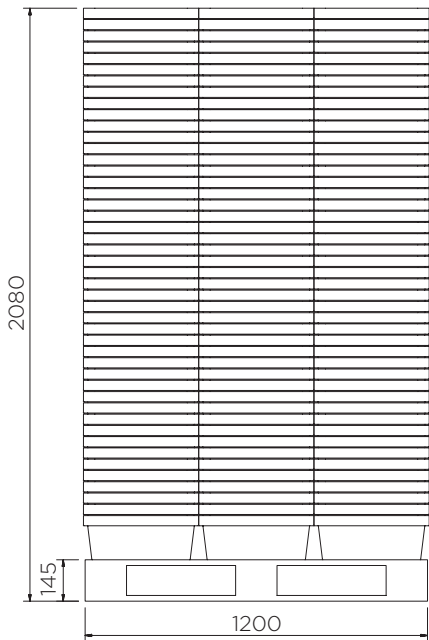

ST1-30-B-BK

| | |
|-------------------------|------|
| Pieces per pallet | 105 |
| 20' container | 1155 |
| 40' high cube container | 2625 |
| 13.6 m trailer | 3465 |

The information is to our best knowledge true and accurate but all recommendations or suggestions are made without guarantee.